



Avery Dennison

Dividers

Plastic Insertable Dividers

- [5 Tab Pocket Insert](#)
- [BIG TAB Inserts for Dividers](#)
- [Insertable Pocket Dividers](#)

Presentation Dividers

- [Direct Print Custom Dividers](#)
- [Direct Print High Speed Presentation Dividers](#)
- [Index Maker Clear Label Dividers](#)
- [Index Maker Clear Label Dividers for Copiers](#)

Reference Dividers

- [Ready Index Table of Contents Dividers](#)
- [Ready Index Translucent Table of Contents Dividers](#)

Tips

[Application of Printable Self-Adhesive Tabs 16280, 16281, 16282, or 16283](#)
[Table of Contents Landscape Product Assembly](#)

For all **Divider Products**, visit our product catalog at: avery.com/us/products

Avery Software Support: 1.888.835.8379

Avery Product Support: 1.800.GO.AVERY (1.800.462.8379)



Plastic Insertable Dividers

- **5 Tab Pocket Insert**
- **BIG TAB Inserts for Dividers**
- **Insertable Pocket Dividers**

1. Test print on a plain sheet of paper.
2. Hold the printed sheet behind the Avery product (or Practice Sheet, if included with this product) to check the alignment of your layout. Slight adjustments to the layout may be necessary.
3. If the entire sheet is slightly misaligned, adjust the top and/or left margins slightly if your program has this feature.
4. When satisfied with the layout, print onto the Avery product.

Print a Half-Sheet - Save the rest for later

Note: Only for printers capable of feeding 8.5" x 5.5" paper sizes.

1. Split insert sheet in half - horizontally.

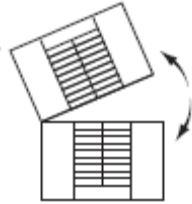

2. Feed into printer on non-perforated side (see arrows on top and bottom of insert sheet).

- Use large size fonts **or print more lines of text on big inserts.**
- Keep inserts from falling **out of tab with secure indent point.**
- Slide in or remove inserts easily **with easy-access notch.**

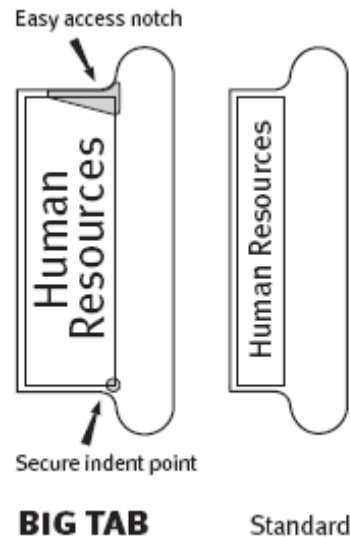

[\[BACK TO TOP\]](#)



Presentation Dividers

Direct Print Custom Dividers

1. Refer to your printer manual for the direction in which you should load divider sheets and for other loading and feeding recommendations.
2. Preview your dividers onscreen before printing.
3. Print on a practice sheet first to ensure proper alignment of text within sections.
4. Print one set of dividers at a time.
5. Don't unfold the dividers before printing.
6. Don't remove the paper strip before printing.
7. Don't run the dividers through your printer more than once.
8. For trouble-free printing, have your printer thoroughly cleaned on a regular basis.

Creating and Printing Avery Direct Print Custom Dividers in Reverse Order – Landscape Orientation

When selecting Landscape orientation in the Avery Direct Print Custom Dividers software the tabs will be ordered from left to right and front to back. These instructions will show you how to reverse order print your dividers as indicated in the illustration below so that:

- Dividers are in Landscape orientation

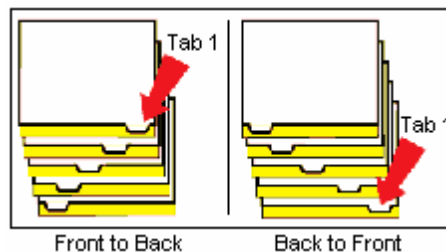

- Tabs read from right to left. (The last 5th or 8th tab position is on left.)
 - Tabs read from back to front or front to back (Back to front is indicated here.)
1. Open the Direct Print Custom Dividers software from within your word processor.

For details refer to the printed instructions or on-line help included with the Direct Print Custom Dividers software.
 2. Select the 5 Tab Divider Set or 8 Tab Divider Set. Select Landscape orientation. Click OK or Create.
 3. Entering your tab text is next. You will need to reverse order the text to get the results you want. For example, where Tab 1 is indicated, you will enter your last (5th or 8th) tab text. Tab 2 should contain your next-to-last tab text. Continue with this order so that Tab 5 or Tab 8 contains your first tab text as illustrated below.

Note: The Direct Print Custom Dividers text entry screen may vary from the one shown here depending on the word processor you are using.



Avery Dennison

4. Once the tab text is entered, continue to format your dividers by adding Body Text, Page Text and/or Graphics as indicated by the software.
5. When satisfied with your formatting, you are ready to print. For information on loading the Avery dividers into your printer, please refer to the Direct Print Custom Dividers printed instructions or on-line help. To check your work, you may want to do a practice run on plain paper before printing onto the dividers.
6. The dividers may need to be reverse collated after printing depending on whether you want Tab 1 in the top right (front to back) or bottom right (back to front) position as indicated here.

[\[BACK TO TOP\]](#)



Avery Dennison

Presentation Dividers

Direct Print High Speed Presentation Dividers

Printing Tips

1. Change the printer setting to feed from the manual paper tray.
2. Test print on an 11" x 17" plain sheet of paper.
3. Hold the printed sheet behind the Avery product (or Practice Sheet, if included with this product) to check the alignment of your layout. Slight adjustments to the layout may be necessary.
4. If the entire sheet is slightly misaligned, adjust the top and/or left margins slightly if your program has this feature.
5. When satisfied with the layout, print onto the Avery product.

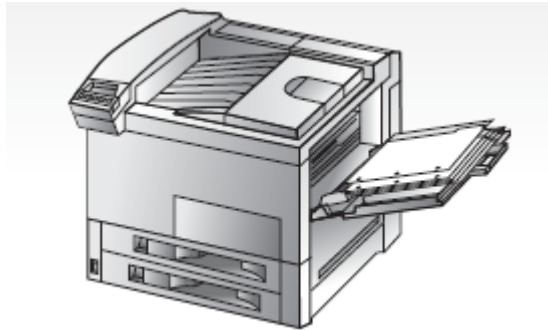

[\[BACK TO TOP\]](#)



Avery Dennison

Presentation Dividers

Index Maker Clear Label Dividers for Copiers

Copying Instructions

Step 1: Create an Original Master

Format your tab titles onto a blank sheet of paper using your computer or typewriter to create an original master. Select *either* the **laser printer** or **typewriter instructions**.

- **For Laser Printers:**
 1. Follow the formatting instructions in these tips to access your template.
 2. Print the tab titles onto a blank sheet of paper using your laser printer.
 3. Check the alignment of the tab titles by comparing the test sheet to the label sheet. Adjust as needed.

- **For Typewriters:**
 1. Place a blank sheet of paper in front of the Practice Sheet (see reverse side of front cover sheet).
 2. Insert both sheets into the typewriter with the blank sheet on top.
 3. Type the tab titles onto the blank sheet within the guide lines.

Step 2: Copy onto Labels

Copy the original master onto the Avery clear label sheet using your copier.

1. Load label sheets, leaving 50 to 100 sheets of paper in the paper tray.
2. Check label sheet orientation. For most copiers, load label side up. Consult your copier manual for exceptions.
3. Select the number of copies desired and touch the start button.

Step 3: Apply Labels to Dividers

Remove the printed labels from the sheet and apply to divider tabs.

[\[BACK TO TOP\]](#)



Avery Dennison

Presentation Dividers

Index Maker Clear Label Dividers

- Run a practice sheet through your printer to test the alignment of the tab titles before using the label sheet.
- Clear labels are designed to run through the printer only once.
- Store label sheets in a protective folder when not in use.

Printing Tips

1. Test print on a plain sheet of paper.
2. Hold the printed sheet behind the enclosed practice sheet or the Avery product to check the alignment of your layout. Slight adjustments to the layout may be necessary.
3. If the entire sheet is slightly misaligned, adjust the top and/or left margins slightly if your program has this feature.
4. When satisfied with the layout, print onto the Avery product.

For a demo of the **Easy Apply Labels**, visit: avery.com/us/products/demos/easy_apply/index.html

[\[BACK TO TOP\]](#)



Avery Dennison

Reference Dividers

Ready Index Table of Contents Dividers

This product is designed for laser and inkjet printers. Use the following tips before printing on the Table of Contents sheet.

1. Test print on a plain sheet of paper.
2. Hold the printed sheet behind the Avery product (or Practice Sheet, if included with this product) to check the alignment of your layout. Slight adjustments to the layout may be necessary.
3. If the entire sheet is slightly misaligned, adjust the top and/or left margins slightly if your program has this feature.
4. When satisfied with the layout, print onto the Avery product.

[\[BACK TO TOP\]](#)



Avery Dennison

Reference Dividers

Ready Index Translucent Table of Contents Dividers

1. Test print on a plain sheet of paper.
2. For the Table of Contents page, place the printed sheet behind the plastic sheet to check the alignment of your layout.
3. Due to variations between printers, slight adjustments to the layout may be necessary. If the entire sheet is slightly misaligned and you can change the margin settings in your software application, try adjusting the top and/or left margins slightly.
4. The plastic divider sheets should **never** be inserted into your printer.
5. When satisfied with the layout, print onto another plain sheet of paper. Assemble the presentation by placing the final printed sheets behind the plastic dividers.

[\[BACK TO TOP\]](#)



Tips

Application of Printable Self-Adhesive Tabs 16280, 16281, 16282, or 16283

Application Tips

NOTE: Tabs are easily repositionable when first applied. Adhesive bond will become more durable and permanent over time. May leave marks, lift ink or damage some paper surfaces when tabs are removed.

1. After you have printed your tabs, peel each tab from the sheet by lifting a corner.

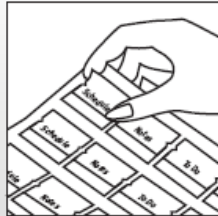

2. Fold back the top portion of the tab, leaving the clear adhesive portion exposed.

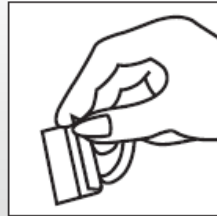

3. Apply the adhesive portion of the tab to the edge of the page.

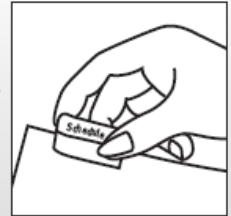

Table of Contents Landscape Product Assembly

1. After printing the Landscape Table of Contents sheet, flip the 3-hole punched divider pages over, with the numbers at the bottom, facing you.
2. Re-assemble the divider pages with the number 1 divider page as the top page, reading from left to right, followed by the number 2 divider page, etc.
3. Place the re-assembled divider pages behind the Table of Contents sheet before putting them into a binder.

[\[BACK TO TOP\]](#)